

AD Base 1 Oracle

Fume Extraction System

User Manual

Installation, Operation, and Service Information



This manual contains specific precautions related to worker safety. The hazard alert image denotes safety related instructions and warnings in this manual. DO NOT install, operate, or perform maintenance on this system until you have read and understood the instructions, precautions and warnings contained within this manual.

Donaldson BOFA Technical Service

If a problem arises with your system, or if it displays a fault code, please refer to the troubleshooting guide section 7 of this manual. If the problem is still not resolved, please:

- Visit our website at donaldsonbofa.com for online help.
- Or contact the helpline:
 - US: +1 (618) 205 5007 (Mon-Fri 9am-5pm CST).
 - ROW: +44 (0) 1202 699 444 (Mon-Fri 9am-5pm GMT)
- Email:
 - US: bofatechnicalus@donaldson.com
 - ROW: bofatechnical@donaldson.com

Serial Number

For future reference, fill in your system details in the space provided. The serial number is on the rating label located on the side/rear of the system.

Table of Contents

1	Overview.....	5
1.1.	Front view of AD Base 1 Oracle	5
1.2.	Rear view of AD Base 1 Oracle	6
1.3.	Overview of control panel	7
2	Safety information	8
2.1.	Important safety notes	8
2.2.	Warning and information labels	9
2.3.	Serial number label	10
2.4.	Fire risk warning	11
3	Before installation	12
3.1.	Packaging removal and system placement	12
4	Installation	13
4.1.	Fume capture methods	13
4.2.	General guidelines for a successful installation	13
4.3.	Flexible arm and nozzle extraction	13
4.4.	Moving products	13
4.5.	Enclosures	13
4.6.	Cabinets	14
4.7.	Connection to extraction system	14
4.8.	Exhausting filtered air outside	14
4.9.	Connection to power supply	14
4.10.	Optional added features	15
4.10.1.	Remote stop/start signal (optional)	15
4.10.2.	DC voltage input (optional)	15
4.10.3.	Volt-free input (optional)	15
4.10.4.	Override (optional)	16
4.10.5.	System OK signal (optional)	16
4.10.6.	Compressor (optional)	16
5	Operation	17
5.1.	Turning extraction system on	17
5.2.	Setting the desired airflow	17
5.2.1.	To set the airflow	18
6	Maintenance	19
6.1.	Maintenance UK	19
6.1.1.	Maintenance general	19
6.1.2.	Cleaning the extraction system	19
6.2.	Replacing filters	19
6.2.1.	Pre-filter replacement	20
6.2.2.	Combined filter replacement	20
7	Troubleshooting.....	21
7.1.	Fault indication	21

8	Replacement parts	22
8.1.	Consumable spares	22
8.2.	Maintenance protocol	22
8.3.	Filter disposal	22
9	System specifications	23
10	Contact information	24
11	Inspection record	25

1 Overview

1.1 Front view of AD Base 1 Oracle

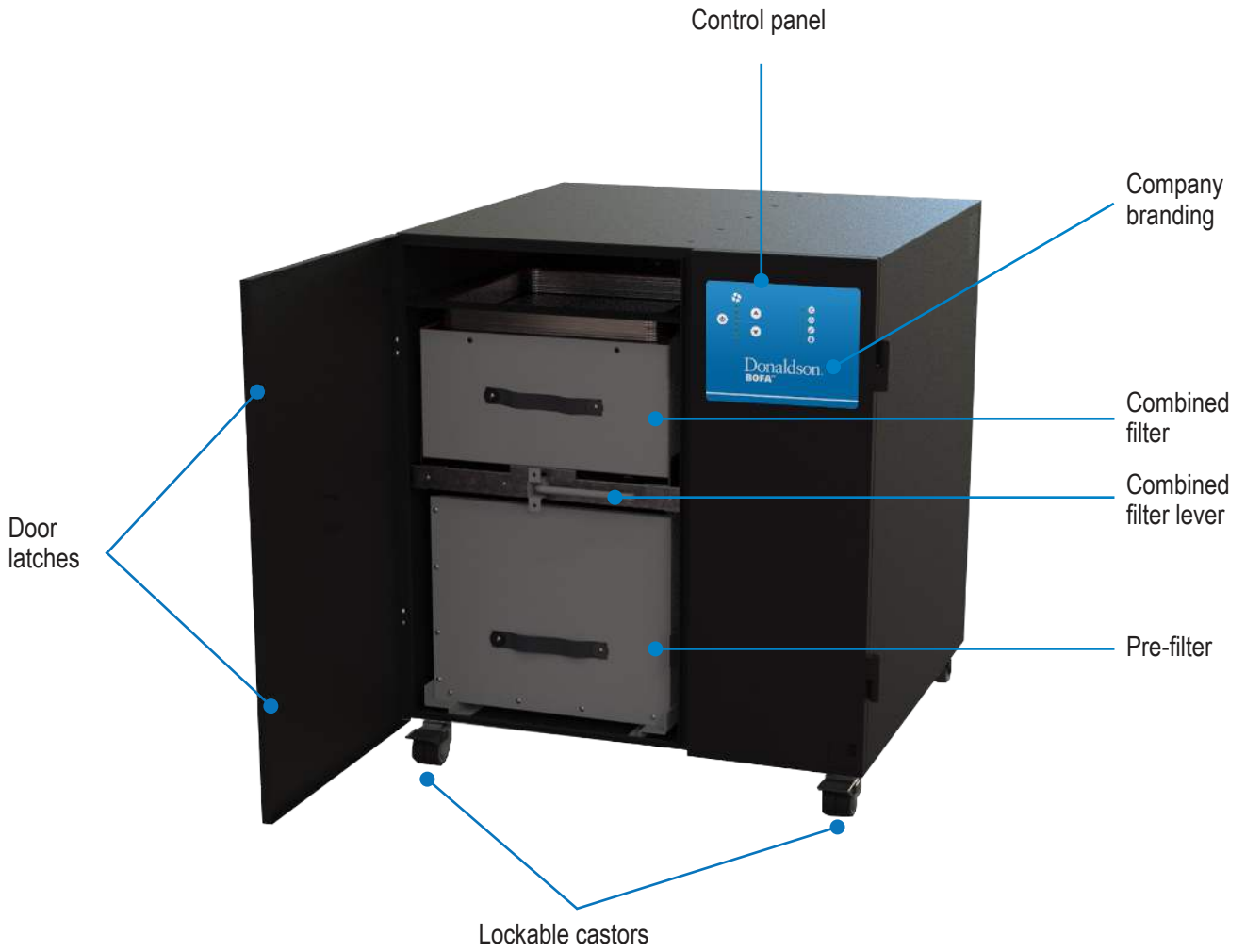

1.2. Rear view of AD Base 1 Oracle

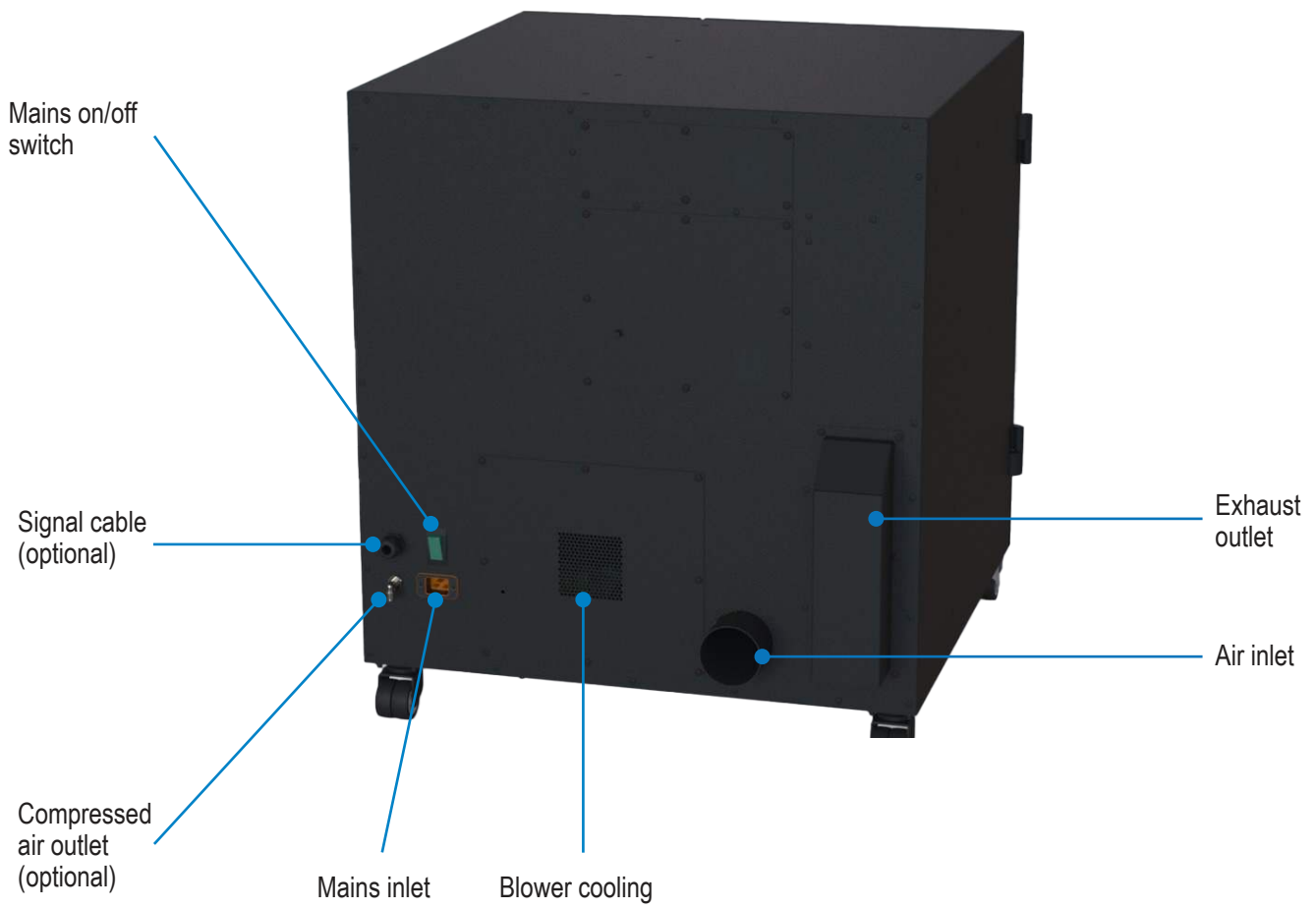

1.3. Overview of control panel



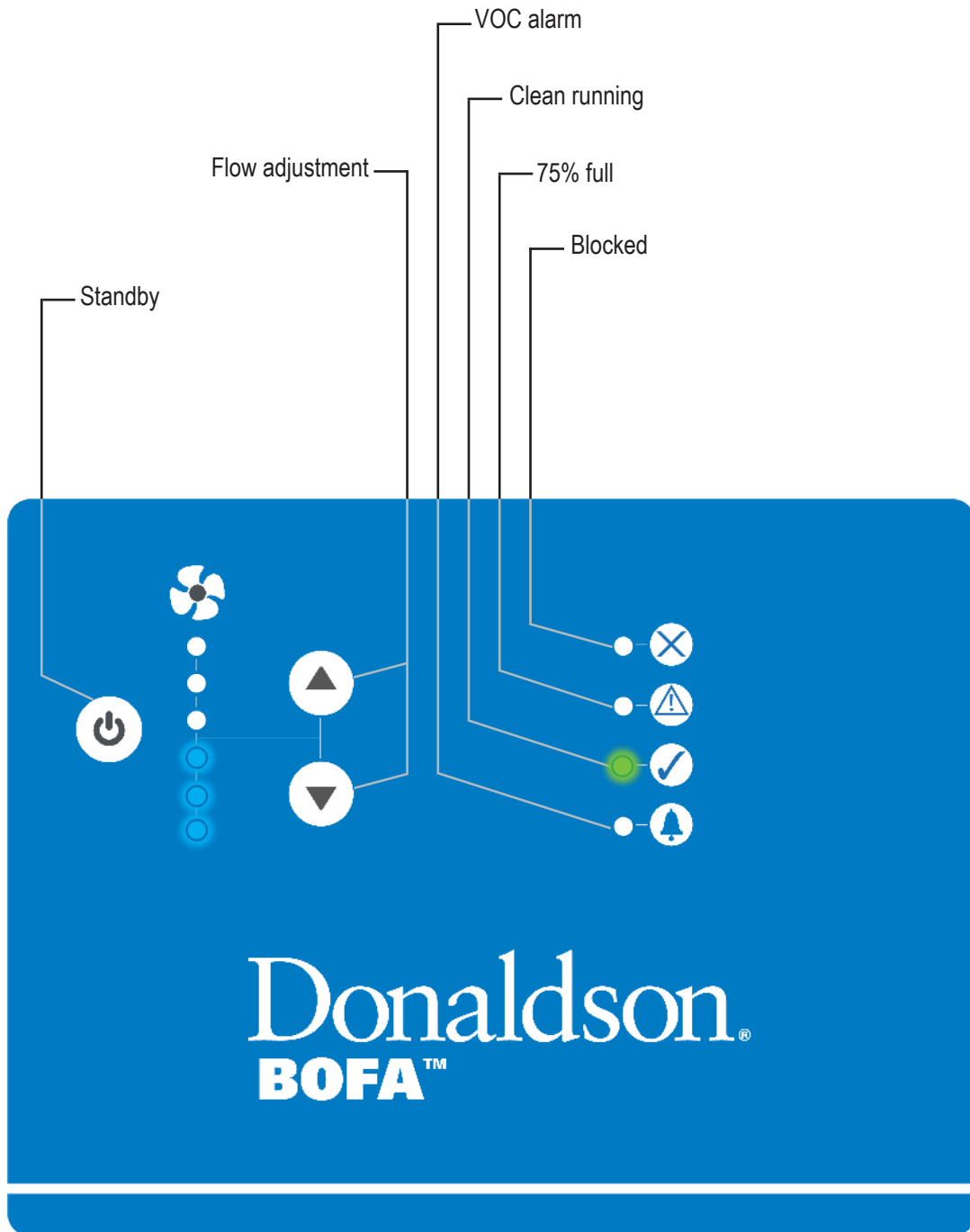

The diagram below shows an overview of the control panel.



2 Safety information

2.1. Important safety notes

Concerning symbols used on the extraction system and referred to within this manual.

Symbol	Meaning	
	DANGER	Refers to an immediately impending danger. If the danger is not avoided, it could result in death or severe (crippling) injury. Please consult the manual when this symbol is displayed.
	WARNING	Refers to a possibly dangerous situation. If not avoided, it could result in death or severe injury. Please consult the manual when this symbol is displayed.
	CAUTION	Refers to a possibly harmful situation. If not avoided, damage could be caused to the product or something in its environment.
	IMPORTANT (refer to manual)	Refers to handling tip and other particularly useful information. This does not signify a dangerous or harmful situation. Refer to manual when this symbol is displayed.

EU Declaration

The system has been designed to meet the essential health and safety requirements of the Machinery Directive 2006/42/EC, Low Voltage Directive 2014/35/EC, and the EMC Directive 2014/30/EU. For the full DOC and further information please contact the technical team:

- US: bofatechnicalus@donaldson.com
- ROW: bofatechnical@donaldson.com

Electrical safety

The system has been designed to meet the essential health and safety requirements of the Low Voltage Directive 2014/35/EC. The requirements of the EMC Directive 2014/30/EU are also met.

Warning

When working with the blower housing open, live 230/115 volt mains components are accessible. Ensure that the rules and regulations for work on live components are always observed.

Important

To reduce the risk of fire, electric shock, or injury:

1. Always isolate the system from the mains power supply before removing the blower access panel.
2. Use only as described in this manual.
3. Connect the system to a properly grounded outlet.

Dangers to eyes, breathing, and skin

Once used, the filters within the extraction system may contain a mixture of particulates, some of which may be sub-micron size. When the used filters are moved, it may agitate some of this particulate, which could get into the breathing zone and eyes of the operative.

Additionally, depending on the materials being processed, the particulate may be an irritant to the skin.

This system should not be used on processes with sparks of flammable materials or with explosive dusts and gases, without implementation of additional precautions.

	CAUTION	When changing used filters, always wear a mask, safety shoes, goggles, and gloves.
---	---------	--

Carbon selection





Please note that the media within the gas filter fitted in the extraction system is capable of adsorbing a wide range of organic compounds. However, it is the responsibility of the user to ensure it is suitable for the particular application it is being used on.

Intended use

This equipment has been designed to extract and filter fume from a variety of applications. However, it is the user’s responsibility to ensure the equipment is installed correctly and is suitable for the application. This extraction system must not be used on wet applications or acidic fumes.

2.2. Warning and information labels

The following listing details labels used on your system.

Symbol	Meaning	
	GOGGLES, GLOVES AND MASK	This appears on filters, indicating that goggles, gloves, and masks should be worn while handling used filters.
	DO NOT COVER	Do not cover any louvers or holes on panels adjacent to the label.
	ELECTRICAL DANGER	Removal of panels with this label attached will allow access to potentially live components.
	WARNING	Power should be isolated before the panel with this label attached is opened/removed.

PLEASE NOTE: If the equipment is used in a manner not specified by the manufacturer, the protection provided by the equipment may be compromised.

2.3. Serial number label



Location: Bottom left side of black panel.

Meaning: This label contains a variety of information about the extraction system, including:

- Company name, address and contact number
- Extraction system model
- Extraction system serial number
- Operating voltage range
- Maximum current load
- Operating frequency
- Year of manufacture
- Relevant approval markings/logos

2.4. Fire risk warning

In the very rare event that a burning ember or spark is drawn into the fume extraction system, it may be possible that the filters will ignite. Whilst any resultant fire would typically be retained within the fume extraction system, the damage to the extraction system could be significant.

It is therefore essential to minimize the possibility of this occurring by undertaking an appropriate risk assessment to determine:

- a). Whether additional fire protection equipment should be installed.
- b). Appropriate maintenance procedures to prevent the risk of build-up of debris which could potentially combust.

This extraction system should not be used on processes where sparks could occur, with explosive dusts and gases, or with particulates that can be pyrophoric (can spontaneously ignite), without implementation of additional precautions. It is essential that nozzles or other extraction/fume capture devices and hoses/pipework are cleaned regularly to prevent the build-up of potentially ignitable debris.

3 Before installation

3.1. Packaging removal and system placement



Before installation, check the extraction system for damage.

All packaging must be removed before the system is connected to the power supply.

Please read all instructions in this manual before using this extraction system.

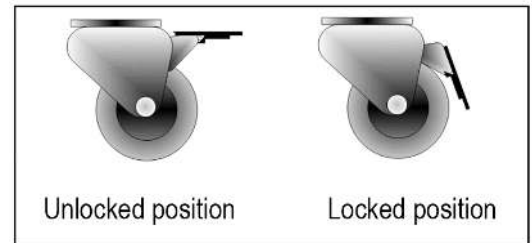
1. Move the system to the location where it is going to be installed and remove the outer packaging.
This system should be installed in a well-ventilated area.
2. Open the front door and remove the transit foam and straps from system. Ensure that 20" (500 mm) space is available around any vented panels on the system to ensure adequate airflow.
3. With the system in position, lock the two front castors.



	CAUTION	Due to the weight of the extraction system, suitable lifting equipment should be used and appropriate safety precautions taken (see system specification section for product weight detail).
	CAUTION	Do not block or cover the cooling vents on the extraction system as this severely restricts airflow and may cause damage to the system.
	CAUTION	Under no circumstances should the exhaust outlet/s be covered as this will restrict the airflow and cause overheating.

4. Check the filters are located in their correct position before closing the door and securing the door latches.

Note: The door will not close fully if the combined filter has not been secured in place using the internal lever (as detailed below).



4 Installation

The system has been designed to remove and filter fume containing potentially hazardous particulate and gases generated during manufacturing processes. Such hazardous substances are captured within a multi-stage filtration system after which the cleaned air is returned to the workplace.

4.1. Fume capture methods

The fume is normally captured by 1 of 3 methods.

- Flexible arm/nozzle
- Enclosures
- Cabinets

4.2. General guidelines for a successful installation

Laser marking/coding used as an example in the following sections and images.

- Keep duct run length to a minimum.
- Avoid sharp bends/turns in the ductwork.
- Avoid multiple bends/turns in the ductwork.
- Use a larger diameter duct where able.
- Position the capture device as close as possible to the marking point (if used on high-speed lines, position the capture device slightly downstream).

4.3. Flexible arm and nozzle extraction

- Stay put arm should be mounted as close as possible to the marking point using the clips provided.
- Unscrew the push-fit connector from the other side of the flexible hose.
- Cut the flexible hose to suit the distance back to the extraction system connection and push onto the system inlet.

Purge air should be kept to a minimum, where possible, to prevent the fume being blown away from the nozzle. High-speed lines may need bigger scoops or nozzles both sides of the product because of the turbulence caused by the speed of the product (e.g., bottling lines).

4.4. Moving products

For applications where the product is moving past the stationary marking point head, the capture nozzle should be positioned as close as possible to the marking area on the side the product is moving towards.

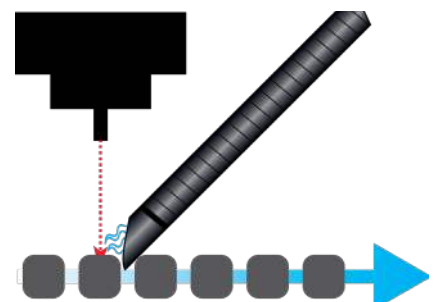

4.5. Enclosures

The extraction hose and nozzle can be attached to the enclosure surrounding the marking zone provided that the extraction point is within 1.96"-2.95" (50-75 mm) of the marking point.

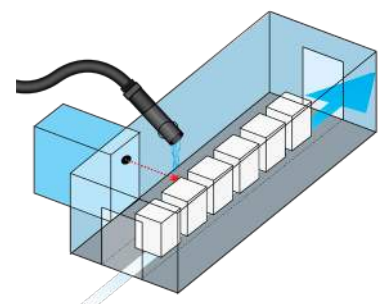

4.6. Cabinets

Cabinets normally have a 2.95" (75 mm) or 3.93" (100 mm) spigot for fume extraction. For best performance, use the same diameter hose as the spigot and reduce at the extraction system end if necessary. **Keep the hose run as short as possible.**

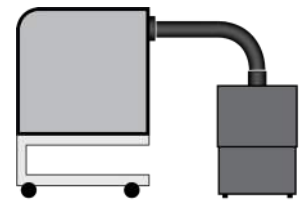

4.7. Connection to extraction system

All ductwork should be installed and connected to the extraction system before it is turned on.

4.8. Exhausting filtered air outside

If requested, your system will have been fitted with an exhaust outlet spigot. This provides a connection point for exhaust pipework to be fitted. It is important to keep any ducting to a minimum to reduce back pressure within the system.

4.9. Connection to power supply

Please follow the specification at the rear of the manual when selecting the power supply outlet for the system. Ensure the power supply is suitable before connecting the system.

	<p>ELECTRICAL DANGER</p>	<p>Check the integrity of the electrical power cable. If the supply cord is damaged, the extraction system should not be connected to the mains. The supply cord should only be replaced by a Donaldson BOFA engineer as an electrical safety test may be required after replacement.</p>
	<p>CAUTION</p>	<p>The system MUST be connected to a properly earthed outlet.</p>

Important - 3 phase systems only: It is very important to ensure that the neutral connection is connected before turning the system on. Failure to do this may result in damage to the extraction system.

If your system was customized for your order, please read the optional features section before the power connection is made as additional connections may be required before power is connected to the extraction system.

Connect the power cable to an isolated electrical supply.

The mains socket should be installed near the extraction system. It should be easily accessible and able to be switched on/off. The cable run must be arranged to prevent trip hazard.

This equipment shall be mounted in accordance with local regulations.

Portable appliance testing guidance

This appliance is a Class I electrical product that requires earth protection. The appliance contains Type 3 SPDs (surge protection devices). During PAT Testing, test voltage L-E and N-E must be limited to 250 VDC to avoid engaging the surge protection.

4.10. Optional added features

The system can be configured to suit customer specification. These optional features would be discussed, arranged, and installed prior to delivery.

If unsure what features your system is equipped with, please contact the seller with the extraction system serial number (refer to section 2 for location), who will be able to advise what specification has been supplied.

For other custom filter signal configurations (details of connectors and pin-outs), these will be included in an appendix at the rear of the manual.

4.10.1. Remote stop/start signal (optional)

Enables the extraction system to be remotely turned on/off via an external signal. This feature can be configured in 3 ways:

- DC voltage input – range 12-24 VDC
- Volt-free input – open/closed contacts
- Override – stop/start feature switched off

Note: Care must be taken to ensure that the system is correctly wired in order for the extraction system to function correctly.

4.10.2. DC voltage input (optional)

This configuration requires the black and red cores of the signal cable (refer to section 1 for location) to be connected to a known and tested DC power supply to start the extraction system.

The operating voltage for this signal is between 12 and 24 VDC. Only voltages within this range should be connected. Voltages connected outside of this range may cause irreversible damage to the internal control PCB.

Red cable = V+

Black cable = V-

When the extraction system is provided with the correct DC voltage, the blower will start and maintain the set flow rate. When the DC voltage is removed, the blower will slow down and come to a stop.

The extraction system will need to be turned on and be out of standby mode in order for this feature to operate.

4.10.3. Volt-free input (optional)

This configuration requires the black and red cores of the signal cable (see section 1 for location) to be connected together in order to start the extraction system.

When the two cables are connected together, the blower will start and maintain the set flow rate. When the two cables are disconnected, the blower will slow down and come to a stop.

The extraction system will need to be turned on and be out of standby mode for this feature to operate.

4.10.4. Override (optional)

Enables the extraction system to operate fully with or without either DC voltage input or the volt-free input.

The override feature can be toggled on/off by a switch mounted on the internal blower access panel (see picture on the right for switch location).

Switch in “on” position

In this position, the extraction system will require a start signal (either voltage input or volt-free, depending on the requested specification) to enable the blower within the system.

Switch in “off” position

In this position, the extraction system blower will run without the requirement for an external start signal. This feature is useful for engineers carrying out works/ tests on the extraction system without the need for the host machine/ auxiliary signal.

The power supply unit which is used to provide the 12-24 VDC stop/start voltage signal must be protected by double insulation from mains voltage.

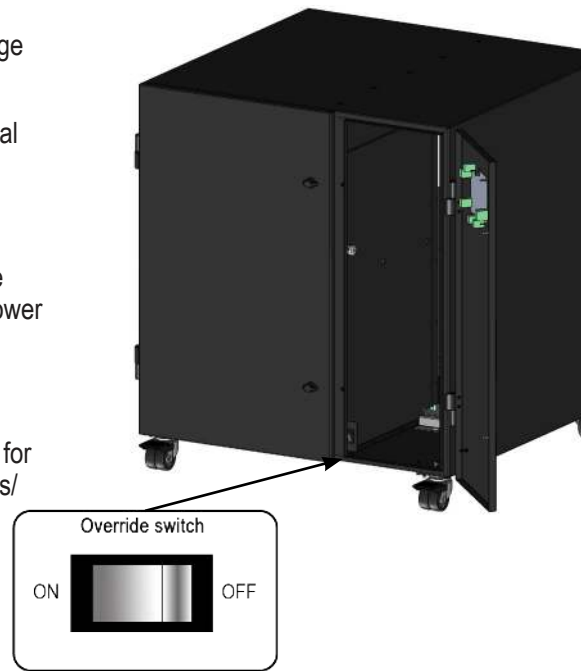

4.10.5. System OK signal (optional)

The extraction system will output a signal to alert the user when the system has failed or when the filters are blocked.

This feature will not directly stop the extraction system from running correctly, but if fitted, this feature should be terminated correctly before power is applied to the system.

Connection specification

This signal is available via the green and white cores of the signal cable. The system will provide a volt-free open/closed signal that can be connected to an external interface, beacon, or warning device following the specification below.

- **Maximum input voltage: 24 VAC**
- **Maximum current load: 3 AAC**

OR

- **Maximum input voltage: 24 VDC**
- **Maximum input load: 3 ADC**

When the filters become blocked or the system develops a fault (refer to troubleshooting section), the connection between the green and white cables will become “open”.

When the extraction system is running normally, the connection between the green and white cables will become “closed”.

4.10.6. Compressor (optional)

If a compressor has been fitted to the extraction system, connect the compressor hose to the system compressor outlet (refer to section 1 for location), and connect the opposite end to the laser (refer to laser installation instructions). A water trap should be fitted to the laser end of the pipework.

5 Operation

5.1 Turning extraction system on

There are two stages to powering up your extraction system. The on/off switch must be switched to the “on” position (refer to section 1 for switch location).

This will place the extraction system in standby mode, indicated by the front panel power button illuminating red.

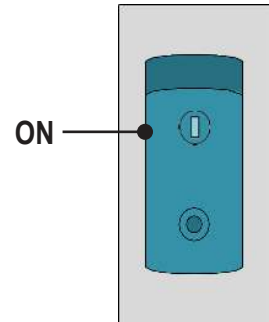

Powder-coated

To start the system, press the front panel power button (refer to section 1 for switch location). The button will change from red to green, indicating the extraction system is now fully on.

It is recommended that the rear on/off switch is left in the on position and the front standby switch is used to toggle the extraction system on/off.

Standby



On

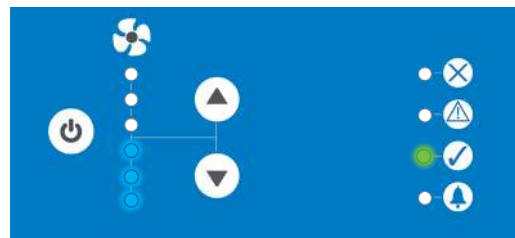

5.2 Setting the desired airflow

The system features automatic flow control. This enables the user to set the required airflow rate, then over time, as the filters begin to block, the blower will automatically begin to increase in speed to compensate for any loss in performance caused by the added restriction of the partially blocked filters.



IMPORTANT
(refer to manual)

The extraction system and all pipework must be fully installed and connected before the airflow is set.

5.2.1. To set the airflow

Airflow capacity is 206 cmf (350 m³/h).

1. Press and hold the “up” and “down” arrow buttons on the front panel for 5 seconds.
2. The green LED will now start to flash, indicating that the system is now in set mode. Press either the “up” or “down” button to adjust the flow rate accordingly.
3. The front panel has six blue LEDs to show airflow. Rating 6 is full speed, 1 is the lowest. Set airflow to the lowest on the 6 LED extraction systems, ensuring fumes are still effectively removed. Airflow needs may vary by application.
4. Once you have achieved your desired flow rate, release the controls for approximately ten to twenty seconds, the system will return to operation mode (this setup procedure should be carried out with all the ductwork connected and, if fitted, the stop/start signal present).

Increase airflow

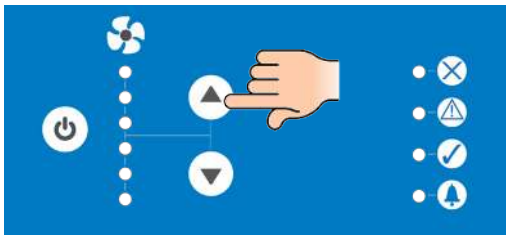

Decrease airflow



6 Maintenance

6.1 Maintenance UK

It is a legal requirement, under regulation 9 of the COSHH regulations, that all local exhaust ventilation systems are thoroughly examined and tested at least once every 14 months (typically carried out annually). The approved code of practice recommends that a visual check should be carried out at least once a week.

COSHH requires the annual inspection and testing to be carried out by a competent person and specifies that documentation results are recorded in a log.

Contact the seller for more information about inspection and certification.

6.1.1 Maintenance general

User maintenance is limited to cleaning the extraction system and filter replacement, only the manufacturers trained maintenance technicians are authorized to carry out component testing and replacement. Unauthorized work or the use of unauthorized replacement filters may result in a potentially dangerous situation and/or damage to the extraction system, and will invalidate the manufacturer's warranty.

6.1.2 Cleaning the extraction system

The powder-coated finish can be cleaned with a damp cloth and non-aggressive detergent, do not use an abrasive cleaning product as this will damage the finish.

The cooling inlets and outlets should be cleaned once a year to prevent build-up of dust and overheating of the extraction system.

6.2 Replacing filters

The system constantly monitors the condition of the filters. During operation, the system will use green, amber, and red LEDs to show the status of its filters:

- Green indicates no issues.
- Amber indicates that one of the filters is 75% full.
- Red signals filter blockage.

The combined or the pre-filters need replacing when the LED to the right of the 'X' icon illuminates red as shown on the right.

A log of the changes should be maintained by the user.

The filters require attention when the display shows the configuration above or when the extraction system no longer removes fume efficiently.

It is recommended that a spare set of filters are kept on-site to avoid prolonged extraction system unavailability. Part numbers for replacement filters can be found on the filters fitted in your system.

To prevent overheating, extraction systems should not be run with a blocked filter condition, or with dust obstruction of inlets/outlets.

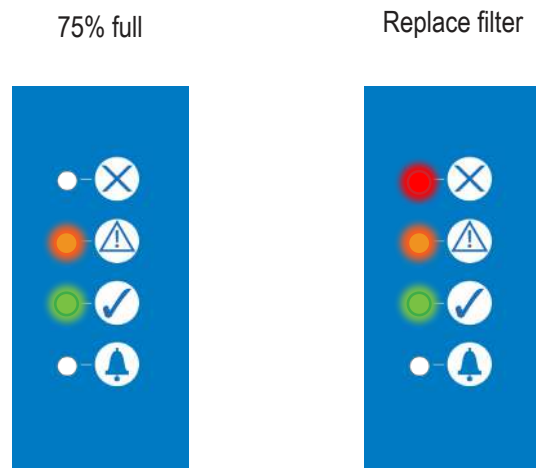

6.2.1. Pre-filter replacement

To remove and replace the pre-filter, follow the procedure detailed below.

1. Isolate the electrical supply to the extraction system.
2. Undo the latches on the front of the extraction system and open the door.
3. The pre-filter is the lower of the two filters (refer to section 1 for filter location). Using the handle on the front of the filter, pull it out of the extraction system. **Important: the handle must only be used for the purpose of pulling out the filter.**
4. Once removed, it is recommended that the used filters are bagged and sealed.
5. Slide in the new filter, ensuring it is fully pushed in and positioned correctly on the spigot in the back of the extraction system.
6. Close the door and fasten the two latches.

If the VOC sensor alarm option is installed in your system, the extraction system will monitor and detect the level of VOC particles in the air. If the VOC level rises above a pre-set level, the LED to the right of the bell symbol will illuminate red (as shown on the right). This indicates that the combined filter needs to be replaced.



6.2.2. Combined filter replacement

To remove and replace the combined filter, follow the procedure detailed below.

1. Isolate the electrical supply to the extraction system.
2. Undo the latches on the front of the extraction system and open the door.
3. The combined filter is the higher of the two filters (refer to section 1 for filter location). Rotate the lever below the filter through 180° to lower the combined filter.
4. Using the front handle, carefully pull the heavy filter out of the extraction system. **Important: the handle must only be used for the purpose of pulling out the filter.**
5. Once removed, it is recommended that the used filters are bagged and sealed.
6. Slide in the new filter, ensuring it is fully pushed in and positioned correctly.
7. Rotate the lever back through 180° to raise the filter into position.
8. Close the door and fasten the two latches.
9. Reconnect the power supply.



All filters MUST be fitted when the system is in use.

7 Troubleshooting

7.1. Fault indication

In the unlikely event of a problem with the extraction system, please contact your local representative.

8 Replacement parts

8.1. Consumable spares

The extraction system contains a pre-filter and a combined filter. These should be replaced when instructed to do so by the system (see maintenance section for replacing filters), when the extraction system is not performing efficiently, or at least once every 12 months.

To maintain performance, it is important that the filters are replaced with identical Donaldson BOFA filters. To reorder, please refer to the filter number printed on the filter installed in your extraction system. See part numbers below:

1. 1UA1030156 (pre-filter)
2. 1UA1030155 (combined filter)

8.2. Maintenance protocol

The data logging function enables the retrieval of filter change intervals. Users may also wish to record changes in the table below.

Extraction System Serial Number:			
Pre-filter (1UA1030156)		Combined filter (1UA1030155)	
Date	Engineer	Date	Engineer

8.3. Filter disposal

The pre-filter and combined filter are manufactured from non-toxic materials. Filters are not reusable, cleaning used filters is not recommended. The method of disposal of the used filters depends on the material deposited on them.

For your guidance:

Deposit	EWC Listing*	Comment
Non-hazardous	15 02 03	Can be disposed of as non-hazardous waste.
Hazardous	15 02 02M	The type of hazard needs to be identified and the associated risks defined. The thresholds for these risks can then be compared with the amount of material in the filters to see if they fall into the hazardous category. If so, the filters will need to be disposed of in line with the local/national regulations.

*European Waste Catalogue

9 System specifications

Extraction system: **AD Base 1 Oracle**

Airflow: 206 cfm (350 m³/h)

Weight: 189 lbs (86 kg)

Airflow measuring system: Windvane

Suction pressure: 96 mBar

Blower: Centrifugal fan

Output: 1.1 kW

Noise Level: Below 64 dB(A) (at operator's position)

Maximum altitude: 2000 m

Electrical supply: 115-230 V

Hertz: 50/60 Hz

Full load current: 12.5 A

Indoor use only

Overvoltage category II

Pollution degree 2

Not for use in wet applications

Environmental operating range:

Temperature: +41 °F (5°C) to + 104 °F (40°C)

Humidity: Max 80% RH up to 87.8 °F (31°C)

Max 50% RH at 104 °F (40°C)

Process fume/gas entering this system should be within the above temperature range.

Wiring schematic and spare parts list available upon request.

Size:

	Imperial (inches)	Metric (mm)
Height	31.1"	790 mm
Width	28.9"	735 mm
Depth	29.1"	740 mm

Filters:

Filter type	Surface area	Efficiency
Pre-filter	129.1 sq ft (12 m ²)	F8 50% @ 0.3 microns
Combined filter	32.2 sq ft (3.0 m ²)	99.995% @ 0.3 microns

Combined filter (gas section):

Filter type	Carbon type	Amount
Combined filter (gas)	Activated carbon	18.8 ltr

10 Contact information

Donaldson BOFA head office – UK & ROW:

19-20 Balena Close

Tel. +44 (0) 1202 699 444

Creekmoor Industrial Estate

Email: bofasales@donaldson.com

Poole

Dorset

BH17 7DU

United Kingdom

Donaldson BOFA German office:

Email: bofavertrieb@donaldson.com

Donaldson BOFA US office:

303 S Madison Street

Tel. +1 (618) 205 5007

Staunton, Illinois

Email: bofasalesus@donaldson.com

62088 USA

11 Inspection record



Donaldson
BOFA™

Inspection Record

Local Exhaust Ventilation System

Health & Safety at Work Act 1974 - Control of Substances Hazardous to Health - Regulation 9 (2002) Thorough Examination and Testing of Local Exhaust Ventilation Systems

Company:	System Designation:	System Installation Date:
Designated Person:		

Inspection and Maintenance Schedules

1. Daily checks.
2. Weekly inspection of process enclosure, extract offtake, hose/ducting, and extraction system.
3. Monthly inspection of process enclosure, extract offtake, hose/ducting, and extraction system.
4. Yearly inspection/testing.

Process enclosure, extract offtake(s), hose/ducting, and extraction system.

Inspection and Maintenance Record

1. Daily inspection

Inspection of the process to ensure extract devices/nozzles/enclosures/hoses are in place and correctly positioned. Examination of the extraction system to ensure it is running. This to be carried out by the operator. Daily inspection not recorded.

2. Weekly inspection

Weekly inspection by supervisor of physical condition of extract devices/nozzles/enclosures/hoses and extraction system for damage, change (parts added or removed) and correct operation, etc. Check also that daily inspections have been completed. Tick boxes to confirm system ok/change. Add details of any changes.

Report changes to Engineering Manager. Record any remedial actions taken.

Week number	Date	System ok	System change	Details of change/repairs, etc.	Initial
1					
2					
3					
4					
5					
6					
7					
8					
9					
10					
11					
12					
13					
14					
15					
16					
17					
18					
19					
20					
21					
22					
23					
24					
25					

Weekly inspection by supervisor of physical condition of extract devices/nozzles/enclosures/hoses and extraction system for damage, change (parts added or removed) and correct operation, etc. Check also that daily inspections have been completed. Tick boxes to confirm system ok/change. Add details of any changes.

Report changes to Engineering Manager. Record any remedial actions taken.

Week number	Date	System ok	System change	Details of change/repairs, etc.	Initial
26					
27					
28					
29					
30					
31					
32					
33					
34					
35					
36					
37					
38					
39					
40					
41					
42					
43					
44					
45					
46					
47					
48					
49					
50					
51					
52					

Process enclosure, extract offtake(s), hose/ducting, and extraction system.

Inspection and Maintenance Record

3. Monthly inspection

In addition to weekly checks, disconnect hoses and check for blockage and smooth operation of fan, signs of dust or vapor/gas/odor carry over. Tick boxes to confirm system ok/change. Add details of any changes. Report changes to Engineering Manager. Record any remedial actions taken.

Week number	Date	System ok	System change	Details of change/repairs, etc.	Initial
1					
2					
3					
4					
5					
6					
7					
8					
9					
10					
11					
12					

4. Yearly inspection

	Comments	Supervisor signature:	Date:
Annual service to include all regular checks, inspection of filter condition, blower, and electrical system, and a filter replacement (if not changed within the previous 12 months).			
Annual thorough inspection and testing of LEV system in accordance with C.O.S.H.H. regulation 9 (max interval 14 months) including reporting.			